

Gender–Case Constraints in Zapotec

Steven Foley, Nick Kalivoda, and Maziar Toosarvandani
University of California, Santa Cruz
{srfoley, nkalivod, mtoosarv}@ucsc.edu

WSCLA 22 – April 22, 2017

1 Introduction

Many languages prohibit certain combinations of clitic arguments based on person: the *Person–Case Constraint (PCC)* (Perlmutter 1971, Bonet 1991).

(1) *Person–Case Constraint (Strong)*

For two clitics A and B, where A c-commands B ($A \gg B$), B must be third person.

(2) *Spanish*

a. 1, 2 \gg 3

Pedro {**me**, **te**} **lo** envía
Pedro {1.DAT, 2.DAT} 3.ACC send.PRES.3SG
'Pedro sends it to {me, you}.'

b. *3 \gg 1, 2

* Pedro **le** {**me**, **te**} envía.
Pedro 3.DAT {1.ACC, 2.ACC} send.PRES.3SG
Intended: 'Pedro sends {me, you} to him.'

(Ormazabal and Romero 2007:316–317)

c. *2 \gg 1

* **Te** **me** van a vender.
2SG.DAT 1SG.ACC go.PRES.3PL to sell.INF
Intended: 'They will sell you to me.'

(Ormazabal and Romero 2007:331)

There are many theories of the PCC. Most rely on Agreement between a head looking for some φ -features — person (π), number ($\#$), or gender (γ) — and one (or more) clitics to license the grammatical combinations.

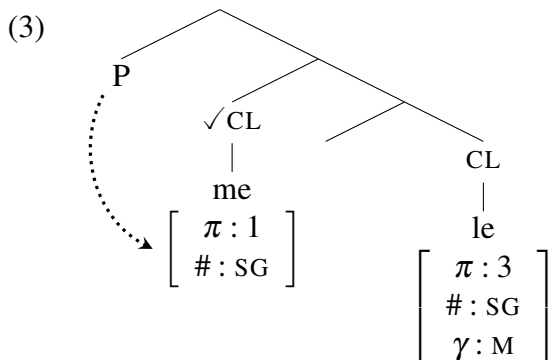

2 Gender–Case Constraints in Zapotec

We focus on four Northern Zapotec varieties, all of which have the same four-way gender system:

ELder human vs. non-elder HUMAN vs. ANimal vs. INanimate

Zapotec languages typically have both strong and clitic pronouns, which distinguish multiple animacy-based gender categories (Marlett 2010a,b).¹

(5) *Strong and clitic pronouns in Santiago Laxopa Zapotec*

	STRONG	CLITIC
1SG	<i>neda'</i>	<i>=a'</i>
1PL.EXCL	<i>dziu'</i>	<i>=dzu</i>
1PL.INCL	<i>neto'</i>	<i>=to'</i>
2SG	<i>lé'</i>	<i>=o'</i>
2PL	<i>le'e</i>	<i>=le'</i>
3.EL	<i>lè'</i>	<i>=(n)e'</i>
3.HU	<i>leba'</i>	<i>=ba'</i>
3.AN	<i>leb</i>	<i>=(e)b</i>
3.IN	<i>len</i>	<i>=(e)n</i>

Clitic pronouns are syntactically and prosodically dependent; strong pronouns appear elsewhere (Cardinaletti and Starke 1999). This contrast is typical of Zapotec languages (Marlett 2010a).

The four varieties we examine today prohibit certain combinations of subject and direct object clitics based on both person and gender:

- Santiago *Laxopa* (original field work, Toosarvandani 2017)
- Hidalgo *Yalálag* (López and Newberg 2005)
- San Baltazar *Yatzachi el Bajo* (Butler 1980)
- San Bartolomé *Zoogocho* (Sonnenschein 2004)

While subject pronouns may always cliticize, object pronouns can only cliticize under certain conditions.

¹Other Zapotec languages have genders specific to adult males, adult females, children, babies, young unmarried men, deities, celestial bodies, liquids, trees and wooden objects, and disparaged/pejorative referents; see Marlett (2010a) for a survey.

2.1 Person restrictions on clitic clusters

All four varieties exhibit the Strong PCC: first or second person direct object pronouns may never cliticize (perhaps not in any Zapotec variety; Marlett 2010a).

- (6) $3 \gg 1$ (*Yalálag*)
- a. * **Wdill=ba'=a'**.
sting.COMP=3.AN=1 SG
Intended: 'It stung me.'
- b. **Wdill=ba' nada'**.
sting.COMP=3.AN 1 SG.IND
'It stung me.'

(López and Newberg 2005)

We set this restriction aside to concentrate on restrictions between third person clitic combinations, which are more complicated (and interesting).

2.2 Gender restrictions on clitic clusters

In *Yalálag*, there is a strict gender hierarchy: *an object clitic must not be higher than the subject clitic on this hierarchy*.

- (7) *Yalálag*: ($1 \not\geq 2 >$) $3.EL > 3.HU > 3.AN > 3.IN$

a.

		OBJECT			
		3.EL	3.HU	3.AN	3.IN
SUBJECT	3.EL	V=e'...le'e	V=e'=be'	V=e'=ba'	V=e'=n
	3.HU	V=be'...le'e	V=be'...lebe'	V=be'=ba'	V=be'=n
	3.AN	V=ba'...le'e	V=ba'...lebe'	V=ba'...leba'	V=ba'=n
	3.IN	V=en...le'e	V=en...lebe'	V=en...leba'	V=en...len

b.

	3.EL	3.HU	3.AN	3.IN
3.EL	—	✓	✓	✓
3.HU	*	—	✓	✓
3.AN	*	*	—	✓
3.IN	*	*	*	—

The dashed cells represent subject and object clitic combinations with totally identical features. Such clusters are always banned — except when a clitic happens to have two allomorphs, e.g. 3.EL in *Yatzachi*.

- (8) $3.EL \gg 3.EL$ (*Yatzachi*)
- a. **Chlo'=e'=ne'**.
teach.CONT=3.EL=3.EL
'S/he (an elder) teaches her/him (an elder).'
- b. * **Chle'i=ne'=ne'**
see.CONT=3.EL=3.EL
Intended: 'S/he (an elder) sees her/him (an elder).'

(Butler 1980)

We take the restriction on these combinations (*X >> X) to be an independent *morphological* constraint on hap-
 lology (Bonet 1991, Nevins 2007, 2011), and so set them aside.

In the other three varieties, the restrictions on clitic clusters are variations on a theme:

- o Laxopa allows every combination Yalálag does, as well as 3.HU >> 3.EL. In other words, it obeys the same gender hierarchy only if the subject is 3.AN or 3.IN. There are no restrictions if the subject is 3.EL or 3.HU.

(9) *Laxopa*: (1 > 2 >) 3.EL > 3.HU > 3.AN > 3.IN

	3.EL	3.HU	3.AN	3.IN
3.EL	–	✓	✓	✓
3.HU	✓	–	✓	✓
3.AN	*	*	–	✓
3.IN	*	*	*	–

- o Yatzachi is the same as Laxopa except for prohibiting 3.AN >> 3.IN. This means it disallows all clitic clusters whose subjects are 3.AN or 3.IN.

(10) *Yatzachi*: (1 > 2 >) 3.EL > 3.HU > 3.AN > 3.IN

	3.EL	3.HU	3.AN	3.IN
3.EL	–	✓	✓	✓
3.HU	✓	–	✓	✓
3.AN	*	*	–	*
3.IN	*	*	*	–

- o Zoogocho is the most liberal variety. It only disallows clitic clusters whose subjects are 3.IN. Or, put another way, it obeys the gender hierarchy only if the subject is 3.IN.

(11) *Zoogocho*: (1 > 2 >) 3.EL > 3.HU > 3.AN > 3.IN

	3.EL	3.HU	3.AN	3.IN
3.EL	–	✓	✓	✓
3.HU	✓	–	✓	✓
3.AN	✓	✓	–	✓
3.IN	*	*	*	–

We call these restrictions on non-identical third-person clitic clusters as *Gender–Case Constraints (GCCs)*. They involve *four* genders (EL vs. HU vs. AN vs. IN), rather than just *three* persons (1 vs. 2 vs. 3).

2.3 The shape of GCCs

These GCCs can be described in one of two ways, based on how they make reference to the following gender hierarchy:

$$EL > HU > AN > IN$$

Either: (i) the gender of the subject clitic is restricted when there is an object clitic, or (ii) the difference between the genders of subject and object clitics is constrained.

These two generalizations can also be characterized in terms of the shape of ungrammatical cells within a paradigm:

- o Zoogocho and Yatzachi (and, potentially, some other yet-to-be-identified varieties) differ in terms of the absolute restriction they impose on the subject when there is an object.

(12) *Rising Floor Generalization*

For any subject–object clitic cluster, if the subject cannot be gender G, then it also cannot be gender G', where $G > G'$ on the hierarchy.

The height of the 'floor' of stars can vary: if a row is ungrammatical, so are all rows below it.

<i>Zoogocho</i>				<i>Yatzachi</i>				<i>(Currently unattested)</i>						
	3.EL	3.HU	3.AN	3.IN		3.EL	3.HU	3.AN	3.IN		3.EL	3.HU	3.AN	3.IN
3.EL	–	✓	✓	✓	3.EL	–	✓	✓	✓	3.EL	–	✓	✓	✓
3.HU	✓	–	✓	✓	3.HU	✓	–	✓	✓	3.HU	*	–	*	*
3.AN	✓	✓	–	✓	3.AN	*	*	–	*	3.AN	*	*	–	*
3.IN	*	*	*	–	3.IN	*	*	*	–	3.IN	*	*	*	–

- o Yalálag, Laxopa, and Zoogocho constrain the relative gender of subject and object clitics, but only if the subject is below a certain rung on the hierarchy.

(13) *Growing Staircase Generalization*

For any subject–object clitic cluster, if an object cannot outrank a subject with gender G, then an object also cannot outrank a subject with gender G', where $G > G'$ on the hierarchy.

If a cell under the $X \gg X$ diagonal is ungrammatical, so is every cell below it or to its left. This creates a 'staircase' of stars up to a certain height.

<i>Zoogocho</i>				<i>Laxopa</i>				<i>Yalálag</i>						
	3.EL	3.HU	3.AN	3.IN		3.EL	3.HU	3.AN	3.IN		3.EL	3.HU	3.AN	3.IN
3.EL	–	✓	✓	✓	3.EL	–	✓	✓	✓	3.EL	–	✓	✓	✓
3.HU	✓	–	✓	✓	3.HU	✓	–	✓	✓	3.HU	*	–	✓	✓
3.AN	✓	✓	–	✓	3.AN	*	*	–	✓	3.AN	*	*	–	✓
3.IN	*	*	*	–	3.IN	*	*	*	–	3.IN	*	*	*	–

This pattern is also manifest with PCCs, albeit in miniature form (Bonet 1991, Nevins 2007, 2011).

(14) a. *Ultrastrong PCC (Classical Arabic)*

	1DO	2DO	3DO
1IO	–	✓	✓
2IO	*	–	✓
3IO	*	*	–

b. *Weak PCC (Catalan)*

	1DO	2DO	3DO
1IO	–	✓	✓
2IO	✓	–	✓
3IO	*	*	–

The ultimate theory of the GCC (and PCC) will have the following properties:

- o The Agree relation that licenses clitic combinations operates in parallel, rather than serially, since features of both clitics in a cluster must be accessible to the probe simultaneously (Sections 3 and 4).
- o Only patterns are generated that obey the Rising Floor and Growing Staircase Generalizations (or combinations thereof), as these highly constrain the variation in possible GCC patterns (Section 5).

3 A serial approach

In serial theories of the PCC, a probe cannot Agree with both clitics in a cluster when the first one it finds is more featurally specified than the second (Anagnostopoulou 2003:286–291, Béjar and Rezac 2003, Walkow 2012, Preminger 2014, a.o.).

When this happens, the second clitic remains fatally unlicensed (e.g. Person Licensing Condition; Béjar and Rezac 2003:53).

- (15) *Clitic Licensing Condition*
A clitic must be licensed by valuing a feature on a φ -probe.

This is a more general constraint, which will permit comparison between serial and parallel theories of the PCC (and by extension the GCC).

3.1 The basic mechanics

Adopting Harley and Ritter’s (2002) feature geometry, person features are *privative*. Pronouns have some combination of three features — $[\pi]$, [PARTICIPANT], and [AUTHOR] — which form an entailment relationship.

- (16)
- | | | |
|-------------------------------------------------|-------------------------------------------|---------|
| 1st | 2nd | 3rd |
| $\begin{bmatrix} \pi \\ PA \\ AU \end{bmatrix}$ | $\begin{bmatrix} \pi \\ PA \end{bmatrix}$ | $[\pi]$ |

In one version of a serial theory, the Strong PCC is derived by locating a probe between the two clitics, and relativizing it to $[\pi]$ and [PA]. The probe Agrees downward before Agreeing upward (Béjar and Rezac 2009).²

- (17) $I \gg 3$
-

Given this configuration, the lower clitic must be third person. With any other combination, the probe will be fully satisfied after Agreeing just once, downward.

- (18) $*3 \gg I$
-

²Under other serial approaches, the probe c-commands both clitics (Béjar and Rezac 2003, Preminger 2014). Then, the probe is relativized just to $[\pi]$ and the licensing condition must be specific just to local person clitics (the Person Licensing Condition).

Thus, the structurally superior clitic is never Agreed with, violating the Clitic Licensing Condition. The ungrammatical $2 \gg 1$ and $1 \gg 2$ combinations are likewise ruled out.

3.2 Extension to the GCC

By analogy to person, the gender categories in Zapotec might also be organized into a feature geometry, comprising four features.

- (19)
- | | | | |
|-------------------------------------------------------------------------------|------------------------------------------------------------------|-----------------------------------------------------|------------|
| 3.EL | 3.HU | 3.AN | 3.IN |
| $\begin{bmatrix} \gamma \\ \text{AN} \\ \text{HU} \\ \text{EL} \end{bmatrix}$ | $\begin{bmatrix} \gamma \\ \text{AN} \\ \text{HU} \end{bmatrix}$ | $\begin{bmatrix} \gamma \\ \text{AN} \end{bmatrix}$ | $[\gamma]$ |

The GCC pattern in Yalálag (the tallest ‘staircase’) can be derived by relativizing the probe to all four gender features (cf. Walkow’s (2012) account of the Ultrastrong PCC in Arabic).

- (20) $3.EL \gg 3.HU$
-

The ungrammatical combinations arise for the same reason as before: the probe is fully satisfied by the lower clitic, so the higher clitic violates the Clitic Licensing Condition.

- (21) $*3.HU \gg 3.EL$
-

The other grammatical clusters in Yalálag are derived in a similar fashion, if Agree is a grammatical operation that can fail — the probe need not find all features it is relativized to (Béjar and Rezac 2009:45, Preminger 2014).

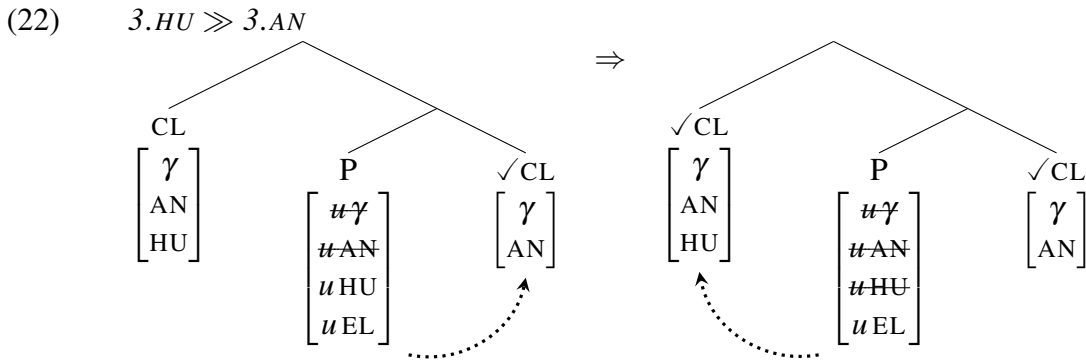

3.3 A problem

While a serial approach can derive the GCC pattern in Yalálag, it cannot generate the GCC patterns in the other three Zapotec varieties.

(23)

	<i>Laxopa</i>				<i>Yatzachi</i>				<i>Zoogocho</i>			
	3.EL	3.HU	3.AN	3.IN	3.EL	3.HU	3.AN	3.IN	3.EL	3.HU	3.AN	3.IN
3.EL	–	✓	✓	✓	3.EL	–	✓	✓	3.EL	–	✓	✓
3.HU	✓	–	✓	✓	3.HU	✓	–	✓	3.HU	✓	–	✓
3.AN	*	*	–	✓	3.AN	*	*	–	3.AN	✓	✓	✓
3.IN	*	*	*	–	3.IN	*	*	–	3.IN	*	*	–

The GCC patterns in Laxopa, Yatzachi, and Zoogocho all collapse two or more gender categories, allowing their members to occur freely with one another.

But no combination of features on the probe generates these patterns under a serial approach; moreover, many implausible patterns are predicted.

	PROBE	PREDICTED CLITIC CLUSTERS	LANGUAGE
L_1	none	none	
L_2	$[u\ \gamma]$	none	
L_3	$[u\ AN]$	none	
L_4	$[u\ HU]$	none	
L_5	$[u\ EL]$	none	
L_6	$[u\ \gamma, AN]$	$3.EL \not> 3.HU \not> 3.AN > 3.IN$	
L_7	$[u\ \gamma, HU]$	$3.EL \not> 3.HU > 3.AN \not> 3.IN$	
L_8	$[u\ \gamma, u\ EL]$	$3.EL > 3.HU \not> 3.AN \not> 3.IN$	
L_9	$[u\ AN, u\ HU]$	$3.EL \not> 3.HU > 3.AN$ (no 3.IN)	
L_{10}	$[u\ AN, u\ EL]$	$3.EL > 3.HU \not> 3.AN$ (no 3.IN)	
L_{11}	$[u\ HU, u\ EL]$	$3.EL > 3.HU$ (no 3.AN or 3.IN)	
L_{12}	$[u\ \gamma, u\ AN, u\ HU]$	$3.EL \not> 3.HU > 3.AN > 3.IN$	
L_{13}	$[u\ \gamma, u\ AN, u\ EL]$	$3.EL > 3.HU \not> 3.AN > 3.IN$	
L_{14}	$[u\ \gamma, u\ HU, u\ EL]$	$3.EL > 3.HU > 3.AN \not> 3.IN$	
L_{15}	$[u\ AN, u\ HU, u\ EL]$	$3.EL > 3.HU > 3.AN$ (no 3.IN)	
L_{16}	$[u\ \gamma, u\ AN, u\ HU, u\ EL]$	$3.EL > 3.HU > 3.AN > 3.IN$	Yalálag

While L_7 and L_{14} — like Yatzachi — do not allow for any combination of animate and inanimate clitics, they both fail to freely allow all combinations of elder and human clitics.

These limitations are inherent to a serial approach. To derive the attested GCC patterns:

- The probe must be able to continue probing after it has Agreed with the lower argument *just in case the higher argument belongs to certain categories* (e.g., in Laxopa, when it is elder or human, but not animal or inanimate).
- Yet, in this theory, a probe’s ability to continue probing is determined entirely by the argument it is currently Agreeing with (i.e., whether or not the first goal values all the probe’s features).

In other words, these grammatical combinations require a form of “look-ahead” that is simply impossible in a myopic serial theory.

4 A parallel approach

Nevins (2007, 2011), following Anagnostopoulou (2005), aims to account for a wider range of PCC patterns using Multiple Agree (Hiraiwa 2001, 2005).

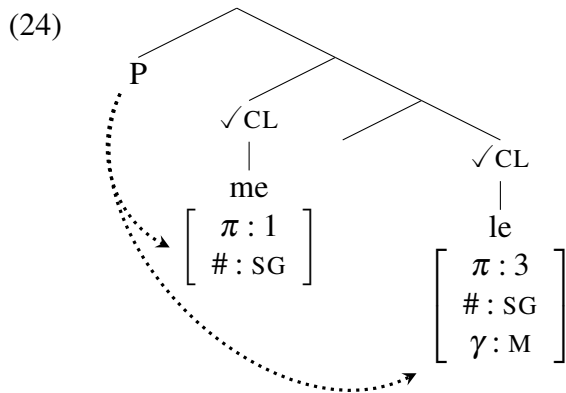

The probe is relativized so that — with certain conditions on Multiple Agree — it can only Agree with some combinations of clitics. Ungrammatical clusters again arise because clitics must be licensed by Agreement, i.e. Clitic Licensing Condition (15).

While Nevins’ parallel theory can be extended to account for the GCC patterns in three Zapotec languages, the pattern in Yatzachi remains a problem.

4.1 The basic mechanics

On Nevins’s theory, Multiple Agree is subject to an intervention condition, which prohibits elements without the features for which the probe is relativized from intervening between it and its goals.

(25) *Contiguous Agree* (cf. Nevins 2007:291)

For a probe P relativized to a feature [+F] with a goal G that bears [+F], there can be no G’ such that:

- P c-commands G’ and G’ c-commands G, and
- G’ does not bear [+F].

(Nevins also countenances relativizing a probe to other values besides the marked value of a feature, though this is not reflected in the definition above.)

For reasons that are immaterial here, Nevins' system assumes that φ -features are bivalent, not privative. Some feature combinations are impossible, e.g. $[+AU] \subset [+PA]$, $[+PA] \subset [+π]$.

(26)

	$[\pm AU]$	$[\pm PA]$	$[\pm π]$
1	+	+	+
2	-	+	+
3	-	-	+

If the probe is relativized to $[+PA]$, this derives the Weak PCC: a third-person clitic cannot c-command a local-person clitic.

(27)

a. $1 \gg 3$

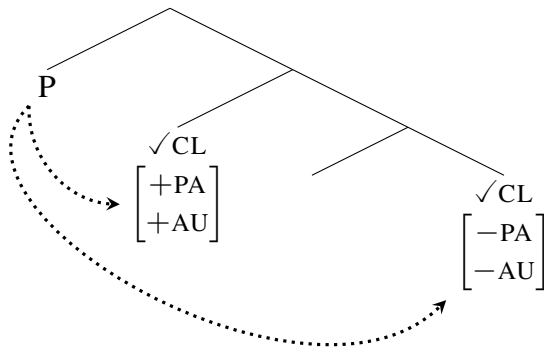

b. $*3 \gg 1$

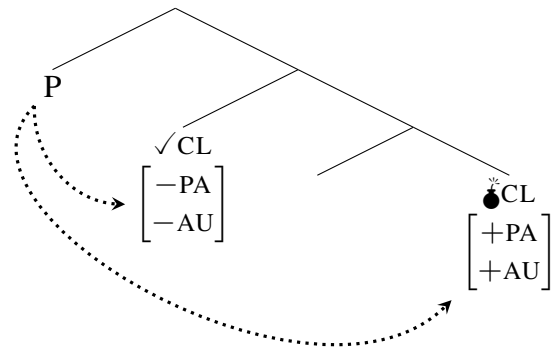

Crucially, to derive the Weak PCC, this still allows for any combination of local-person clitics, as then they are both $[+PA]$ and Contiguous Agree is not violated.

(28)

a. $1 \gg 2$

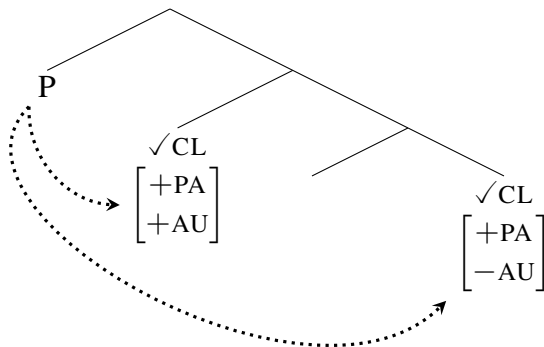

b. $2 \gg 1$

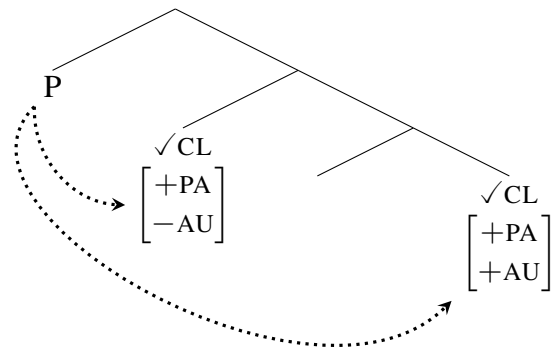

4.2 Extension to the GCC

To make them compatible with Nevins' system, the featural specifications for gender in Zapotec can be recast. Again, entailment relations among features obtain: $[+EL] \subset [+HU] \subset [+AN] \subset [+γ]$.

(29)

	$[\pm EL]$	$[\pm HU]$	$[\pm AN]$	$[\pm γ]$
3.EL	+	+	+	+
3.HU	-	+	+	+
3.AN	-	-	+	+
3.IN	-	-	-	+

The probe can be relativized to the marked value for any one of these features.

(30)	<p>a. <i>Relativization: [+EL]</i></p> <table style="width: 100%; border-collapse: collapse;"> <thead> <tr> <th></th> <th>3.EL</th> <th>3.HU</th> <th>3.AN</th> <th>3.IN</th> </tr> </thead> <tbody> <tr> <td>3.EL</td> <td>–</td> <td>✓</td> <td>✓</td> <td>✓</td> </tr> <tr> <td>3.HU</td> <td>*</td> <td>–</td> <td>✓</td> <td>✓</td> </tr> <tr> <td>3.AN</td> <td>*</td> <td>✓</td> <td>–</td> <td>✓</td> </tr> <tr> <td>3.IN</td> <td>*</td> <td>✓</td> <td>✓</td> <td>–</td> </tr> </tbody> </table> <p>c. <i>Relativization: [+AN]</i></p> <table style="width: 100%; border-collapse: collapse;"> <thead> <tr> <th></th> <th>3.EL</th> <th>3.HU</th> <th>3.AN</th> <th>3.IN</th> </tr> </thead> <tbody> <tr> <td>3.EL</td> <td>–</td> <td>✓</td> <td>✓</td> <td>✓</td> </tr> <tr> <td>3.HU</td> <td>✓</td> <td>–</td> <td>✓</td> <td>✓</td> </tr> <tr> <td>3.AN</td> <td>✓</td> <td>✓</td> <td>–</td> <td>✓</td> </tr> <tr> <td>3.IN</td> <td>*</td> <td>*</td> <td>*</td> <td>–</td> </tr> </tbody> </table>		3.EL	3.HU	3.AN	3.IN	3.EL	–	✓	✓	✓	3.HU	*	–	✓	✓	3.AN	*	✓	–	✓	3.IN	*	✓	✓	–		3.EL	3.HU	3.AN	3.IN	3.EL	–	✓	✓	✓	3.HU	✓	–	✓	✓	3.AN	✓	✓	–	✓	3.IN	*	*	*	–	<p>b. <i>Relativization: [+HU]</i></p> <table style="width: 100%; border-collapse: collapse;"> <thead> <tr> <th></th> <th>3.EL</th> <th>3.HU</th> <th>3.AN</th> <th>3.IN</th> </tr> </thead> <tbody> <tr> <td>3.EL</td> <td>–</td> <td>✓</td> <td>✓</td> <td>✓</td> </tr> <tr> <td>3.HU</td> <td>✓</td> <td>–</td> <td>✓</td> <td>✓</td> </tr> <tr> <td>3.AN</td> <td>*</td> <td>*</td> <td>–</td> <td>✓</td> </tr> <tr> <td>3.IN</td> <td>*</td> <td>*</td> <td>✓</td> <td>–</td> </tr> </tbody> </table> <p>d. <i>Relativization: [+γ]</i></p> <table style="width: 100%; border-collapse: collapse;"> <thead> <tr> <th></th> <th>3.EL</th> <th>3.HU</th> <th>3.AN</th> <th>3.IN</th> </tr> </thead> <tbody> <tr> <td>3.EL</td> <td>–</td> <td>✓</td> <td>✓</td> <td>✓</td> </tr> <tr> <td>3.HU</td> <td>✓</td> <td>–</td> <td>✓</td> <td>✓</td> </tr> <tr> <td>3.AN</td> <td>✓</td> <td>✓</td> <td>–</td> <td>✓</td> </tr> <tr> <td>3.IN</td> <td>✓</td> <td>✓</td> <td>✓</td> <td>–</td> </tr> </tbody> </table>		3.EL	3.HU	3.AN	3.IN	3.EL	–	✓	✓	✓	3.HU	✓	–	✓	✓	3.AN	*	*	–	✓	3.IN	*	*	✓	–		3.EL	3.HU	3.AN	3.IN	3.EL	–	✓	✓	✓	3.HU	✓	–	✓	✓	3.AN	✓	✓	–	✓	3.IN	✓	✓	✓	–
	3.EL	3.HU	3.AN	3.IN																																																																																																		
3.EL	–	✓	✓	✓																																																																																																		
3.HU	*	–	✓	✓																																																																																																		
3.AN	*	✓	–	✓																																																																																																		
3.IN	*	✓	✓	–																																																																																																		
	3.EL	3.HU	3.AN	3.IN																																																																																																		
3.EL	–	✓	✓	✓																																																																																																		
3.HU	✓	–	✓	✓																																																																																																		
3.AN	✓	✓	–	✓																																																																																																		
3.IN	*	*	*	–																																																																																																		
	3.EL	3.HU	3.AN	3.IN																																																																																																		
3.EL	–	✓	✓	✓																																																																																																		
3.HU	✓	–	✓	✓																																																																																																		
3.AN	*	*	–	✓																																																																																																		
3.IN	*	*	✓	–																																																																																																		
	3.EL	3.HU	3.AN	3.IN																																																																																																		
3.EL	–	✓	✓	✓																																																																																																		
3.HU	✓	–	✓	✓																																																																																																		
3.AN	✓	✓	–	✓																																																																																																		
3.IN	✓	✓	✓	–																																																																																																		

These relativizations can be combined to derive the GCC patterns in three of the Zapotec languages: Zoogocho, Laxopa, and Yalálag.

(31)	<p>a. <i>Zoogocho = [+AN, +γ]</i></p> <table style="width: 100%; border-collapse: collapse;"> <thead> <tr> <th></th> <th>3.EL</th> <th>3.HU</th> <th>3.AN</th> <th>3.IN</th> </tr> </thead> <tbody> <tr> <td>3.EL</td> <td>–</td> <td>✓</td> <td>✓</td> <td>✓</td> </tr> <tr> <td>3.HU</td> <td>✓</td> <td>–</td> <td>✓</td> <td>✓</td> </tr> <tr> <td>3.AN</td> <td>✓</td> <td>✓</td> <td>–</td> <td>✓</td> </tr> <tr> <td>3.IN</td> <td>*</td> <td>*</td> <td>*</td> <td>–</td> </tr> </tbody> </table> <p>c. <i>Yalálag = [+EL, +HU, +AN, +γ]</i></p> <table style="width: 100%; border-collapse: collapse;"> <thead> <tr> <th></th> <th>3.EL</th> <th>3.HU</th> <th>3.AN</th> <th>3.IN</th> </tr> </thead> <tbody> <tr> <td>3.EL</td> <td>–</td> <td>✓</td> <td>✓</td> <td>✓</td> </tr> <tr> <td>3.HU</td> <td>*</td> <td>–</td> <td>✓</td> <td>✓</td> </tr> <tr> <td>3.AN</td> <td>*</td> <td>*</td> <td>–</td> <td>✓</td> </tr> <tr> <td>3.IN</td> <td>*</td> <td>*</td> <td>*</td> <td>–</td> </tr> </tbody> </table>		3.EL	3.HU	3.AN	3.IN	3.EL	–	✓	✓	✓	3.HU	✓	–	✓	✓	3.AN	✓	✓	–	✓	3.IN	*	*	*	–		3.EL	3.HU	3.AN	3.IN	3.EL	–	✓	✓	✓	3.HU	*	–	✓	✓	3.AN	*	*	–	✓	3.IN	*	*	*	–	<p>b. <i>Laxopa = [+HU, +AN, +γ]</i></p> <table style="width: 100%; border-collapse: collapse;"> <thead> <tr> <th></th> <th>3.EL</th> <th>3.HU</th> <th>3.AN</th> <th>3.IN</th> </tr> </thead> <tbody> <tr> <td>3.EL</td> <td>–</td> <td>✓</td> <td>✓</td> <td>✓</td> </tr> <tr> <td>3.HU</td> <td>✓</td> <td>–</td> <td>✓</td> <td>✓</td> </tr> <tr> <td>3.AN</td> <td>*</td> <td>*</td> <td>–</td> <td>✓</td> </tr> <tr> <td>3.IN</td> <td>*</td> <td>*</td> <td>*</td> <td>–</td> </tr> </tbody> </table>		3.EL	3.HU	3.AN	3.IN	3.EL	–	✓	✓	✓	3.HU	✓	–	✓	✓	3.AN	*	*	–	✓	3.IN	*	*	*	–
	3.EL	3.HU	3.AN	3.IN																																																																									
3.EL	–	✓	✓	✓																																																																									
3.HU	✓	–	✓	✓																																																																									
3.AN	✓	✓	–	✓																																																																									
3.IN	*	*	*	–																																																																									
	3.EL	3.HU	3.AN	3.IN																																																																									
3.EL	–	✓	✓	✓																																																																									
3.HU	*	–	✓	✓																																																																									
3.AN	*	*	–	✓																																																																									
3.IN	*	*	*	–																																																																									
	3.EL	3.HU	3.AN	3.IN																																																																									
3.EL	–	✓	✓	✓																																																																									
3.HU	✓	–	✓	✓																																																																									
3.AN	*	*	–	✓																																																																									
3.IN	*	*	*	–																																																																									

4.3 The problem with Yatzachi

It is not possible to generate the GCC pattern in Yatzachi by relativizing to the marked value for any combination of gender features, because these do not rule out the ungrammatical combination 3.AN ≫ 3.IN.

(32)	<p><i>Yatzachi (1 ≧ 2 >) 3EL ≧ 3HU > 3AN ≧ 3IN</i></p> <table style="width: 100%; border-collapse: collapse;"> <thead> <tr> <th></th> <th>3.EL</th> <th>3.HU</th> <th>3.AN</th> <th>3.IN</th> </tr> </thead> <tbody> <tr> <td>3.EL</td> <td>–</td> <td>✓</td> <td>✓</td> <td>✓</td> </tr> <tr> <td>3.HU</td> <td>✓</td> <td>–</td> <td>✓</td> <td>✓</td> </tr> <tr> <td>3.AN</td> <td>*</td> <td>*</td> <td>–</td> <td>*</td> </tr> <tr> <td>3.IN</td> <td>*</td> <td>*</td> <td>*</td> <td>–</td> </tr> </tbody> </table>		3.EL	3.HU	3.AN	3.IN	3.EL	–	✓	✓	✓	3.HU	✓	–	✓	✓	3.AN	*	*	–	*	3.IN	*	*	*	–
	3.EL	3.HU	3.AN	3.IN																						
3.EL	–	✓	✓	✓																						
3.HU	✓	–	✓	✓																						
3.AN	*	*	–	*																						
3.IN	*	*	*	–																						

Is there another way of accounting for Yatzachi? To account for the Strong PCC, Nevins imposes an additional constraint, *Matched Values*, on Multiple Agree, cf. Anagnostopoulou (2005)

(33) *Matched Values*

For a probe P relativized to a *contrastive* value for feature $[\pm F]$, every goal G must match in its value for $[\pm F]$.

This constraint only has an effect when the probe is relativized to the *contrastive* value for a feature.

(34) A pronoun S with specification $[\alpha F]$ is *contrastive* for [F] if there is another pronoun S' in the inventory that is featurally identical to S, except that it is $[-\alpha F]$. (Nevins 2007:289)

Without getting bogged down in the details, a probe with a contrastive relativization rules out adjacent columns in a paradigm.

(35)	a.	<i>Relativization: Contrastive $[\pm EL]$</i>				b.	<i>Relativization: Contrastive $[\pm HU]$</i>				
		3.EL	3.HU	3.AN	3.IN		3.EL	3.HU	3.AN	3.IN	
		3.EL	–	*	✓	✓	3.EL	–	*	*	✓
		3.HU	*	–	✓	✓	3.HU	✓	–	*	✓
		3.AN	*	*	–	✓	3.AN	✓	*	–	✓
		3.IN	*	*	✓	–	3.IN	✓	*	*	–

(35)	c.	<i>Relativization: Contrastive $[\pm AN]$</i>				
		3.EL	3.HU	3.AN	3.IN	
		3.EL	–	✓	*	*
		3.HU	✓	–	*	*
		3.AN	✓	✓	–	*
		3.IN	✓	✓	*	–

Clearly, adding Matched Values does not account for the GCC pattern in Yatzachi, where just the bottom two rows should be ruled out.

Moreover, relativizing to contrastive features also predicts GCC patterns which are highly implausible given our Growing Staircase and Rising Floor generalizations.

(36)	a.	$[+HU]$, <i>Contrastive $[\pm HU]$</i>				b.	$[+EL]$, <i>Contrastive $[\pm AN]$</i>				
		3.EL	3.HU	3.AN	3.IN		3.EL	3.HU	3.AN	3.IN	
		3.EL	–	*	*	✓	3.EL	–	✓	*	*
		3.HU	✓	–	*	✓	3.HU	*	–	*	*
		3.AN	*	*	–	✓	3.AN	*	✓	–	*
		3.IN	*	*	*	–	3.IN	*	✓	*	–

While a parallel approach with an intervention condition like Contiguous Agree accounts for most GCC patterns, it runs into problems with the GCC in Yatzachi.

5.2 Dealing with Yatzachi

Recall that the GCC pattern in Yatzachi is not derived by Nevins' original Contiguous Agree because the highest clitic in *any* cluster must always be [+HU] (though [-HU] subject clitics are permitted outside of clusters).

With Liberal Contiguous Agree, the probe in Yatzachi can be relativized to [+ γ]/[+HU]. This rules out clusters in which the lower clitic is [+ γ] (i.e., it has gender of any kind) and the higher clitic is [-HU].

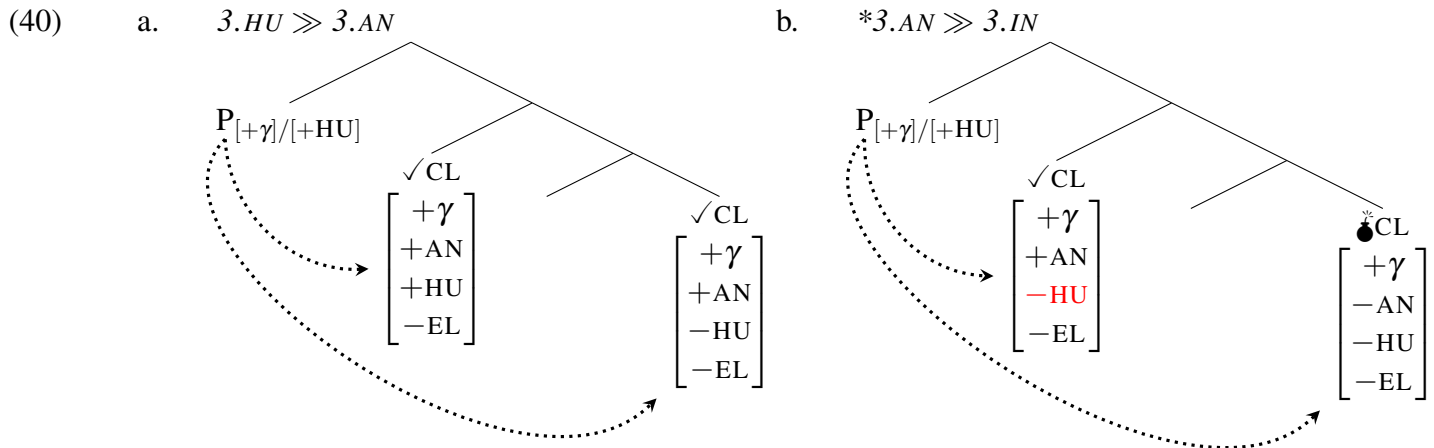

In fact, this derives the Rising Floor Generalization, if Zoogocho is conceived of as ruling out the entire bottom row of a paradigm.

<i>Zoogocho</i> = [+ γ]/[+AN]					<i>Yatzachi</i> = [+ γ]/[+HU]					[+ γ]/[+EL] (<i>unattested</i>)				
	3.EL	3.HU	3.AN	3.IN		3.EL	3.HU	3.AN	3.IN		3.EL	3.HU	3.AN	3.IN
3.EL	-	✓	✓	✓	3.EL	-	✓	✓	✓	3.EL	-	✓	✓	✓
3.HU	✓	-	✓	✓	3.HU	✓	-	✓	✓	3.HU	*	-	*	*
3.AN	✓	✓	-	✓	3.AN	*	*	-	*	3.AN	*	*	-	*
3.IN	*	*	*	-	3.IN	*	*	*	-	3.IN	*	*	*	-

5.3 Typological predictions

There are 10 possible relativizations for probes, assuming Liberal Contiguous Agree as a constraint on Multiple Agree.

- (41)
- | | | | |
|---------------------|---------------------|---------------------|-----------------------------|
| [+EL]/[+EL] | | | |
| [+HU]/[+EL] | [+HU]/[+HU] | | |
| [+AN]/[+EL] | [+AN]/[+HU] | [+AN]/[+AN] | |
| [+ γ]/[+EL] | [+ γ]/[+HU] | [+ γ]/[+AN] | [+ γ]/[+ γ] |

Despite there being 1024 (2^{10}) combinations of these relativizations, there are only 28 extensionally distinct languages predicted, because many of these probes have overlapping consequences.

(42)

L_1	EL HU AN IN	L_2	EL HU AN IN	L_3	EL HU AN IN	L_4	EL HU AN IN
EL	✓ ✓ ✓ ✓	EL	✓ ✓ ✓ ✓	EL	✓ ✓ ✓ ✓	EL	✓ ✓ ✓ ✓
HU	✓ ✓ ✓ ✓	HU	✓ ✓ ✓ ✓	HU	✓ ✓ ✓ ✓	HU	✓ ✓ ✓ ✓
AN	✓ ✓ ✓ ✓	AN	✓ ✓ ✓ ✓	AN	✓ ✓ ✓ ✓	AN	* * ✓ ✓
IN	✓ ✓ ✓ ✓	IN	* * * ✓	IN	* * * *	IN	* * ✓ ✓
L_5	EL HU AN IN	L_6	EL HU AN IN	L_7	EL HU AN IN	L_8	EL HU AN IN
EL	✓ ✓ ✓ ✓	EL	✓ ✓ ✓ ✓	EL	✓ ✓ ✓ ✓	EL	✓ ✓ ✓ ✓
HU	✓ ✓ ✓ ✓	HU	✓ ✓ ✓ ✓	HU	✓ ✓ ✓ ✓	HU	✓ ✓ ✓ ✓
AN	* * ✓ ✓	AN	* * ✓ ✓	AN	* * * ✓	AN	* * * ✓
IN	* * * ✓	IN	* * * *	IN	* * * ✓	IN	* * * *
L_9	EL HU AN IN	L_{10}	EL HU AN IN	L_{11}	EL HU AN IN	L_{12}	EL HU AN IN
EL	✓ ✓ ✓ ✓	EL	✓ ✓ ✓ ✓	EL	✓ ✓ ✓ ✓	EL	✓ ✓ ✓ ✓
HU	✓ ✓ ✓ ✓	HU	* ✓ ✓ ✓	HU	* ✓ ✓ ✓	HU	* ✓ ✓ ✓
AN	* * * *	AN	* ✓ ✓ ✓	AN	* ✓ ✓ ✓	AN	* ✓ ✓ ✓
IN	* * * *	IN	* ✓ ✓ ✓	IN	* * * ✓	IN	* * * *
L_{13}	EL HU AN IN	L_{14}	EL HU AN IN	L_{15}	EL HU AN IN	L_{16}	EL HU AN IN
EL	✓ ✓ ✓ ✓	EL	✓ ✓ ✓ ✓	EL	✓ ✓ ✓ ✓	EL	✓ ✓ ✓ ✓
HU	* ✓ ✓ ✓	HU	* ✓ ✓ ✓	HU	* ✓ ✓ ✓	HU	* ✓ ✓ ✓
AN	* * ✓ ✓	AN	* * ✓ ✓	AN	* * ✓ ✓	AN	* * * ✓
IN	* * ✓ ✓	IN	* * * ✓	IN	* * * *	IN	* * * ✓
L_{17}	EL HU AN IN	L_{18}	EL HU AN IN	L_{19}	EL HU AN IN	L_{20}	EL HU AN IN
EL	✓ ✓ ✓ ✓	EL	✓ ✓ ✓ ✓	EL	✓ ✓ ✓ ✓	EL	✓ ✓ ✓ ✓
HU	* ✓ ✓ ✓	HU	* ✓ ✓ ✓	HU	* * ✓ ✓	HU	* * ✓ ✓
AN	* * * ✓	AN	* * * *	AN	* * ✓ ✓	AN	* * * ✓
IN	* * * *	IN	* * * *	IN	* * ✓ ✓	IN	* * * ✓
L_{21}	EL HU AN IN	L_{22}	EL HU AN IN	L_{23}	EL HU AN IN	L_{24}	EL HU AN IN
EL	✓ ✓ ✓ ✓	EL	✓ ✓ ✓ ✓	EL	✓ ✓ ✓ ✓	EL	✓ ✓ ✓ ✓
HU	* * ✓ ✓	HU	* * ✓ ✓	HU	* * ✓ ✓	HU	* * ✓ ✓
AN	* * ✓ ✓	AN	* * * ✓	AN	* * * ✓	AN	* * * *
IN	* * * *	IN	* * * *	IN	* * * *	IN	* * * *
L_{25}	EL HU AN IN	L_{26}	EL HU AN IN	L_{27}	EL HU AN IN	L_{28}	EL HU AN IN
EL	✓ ✓ ✓ ✓	EL	✓ ✓ ✓ ✓	EL	✓ ✓ ✓ ✓	EL	✓ ✓ ✓ ✓
HU	* * * ✓	HU	* * * ✓	HU	* * * ✓	HU	* * * *
AN	* * * ✓	AN	* * * ✓	AN	* * * *	AN	* * * *
IN	* * * ✓	IN	* * * *	IN	* * * *	IN	* * * *

There are two ways this typology might plausibly be restricted even further, so that it approximates the attested GCC patterns more closely:

- Many of these languages differ solely in the grammaticality of one or more totally identical clitic combinations, e.g. $IN \gg IN$ in L_5 and L_6 . Such illicit combinations might also be attributed to a morphological haplology constraint. It is difficult to resolve this analytical uncertainty, which might in principle even extend to the language learner, cf. Han et al. (2007). Ignoring differences between languages in identical clitic clusters yields just 13 distinct surface patterns.
- The relativizations for the probes in Zoogocho, Laxopa, and Yalálag stand in a subset relation to one another (31). This may reflect a more general constraint, along the lines of Béjar and Rezac (2009), who require that, if a probe looks for some feature, it also look for every feature it entails.

6 Conclusion and future prospects

These GCC effects in Zapotec look very similar to the more familiar PCC. But they provide a new window into the source of these ‘ φ CC’ patterns.:

- While the PCC constrains clitic clusters based on three features (π , PA, AU), the GCC involves four features (γ , AN, HU, EL), revealing important patterns that were not readily apparent in the smaller PCC paradigms.
- Our account of these patterns appeals to Liberal Contiguous Agree (38), an intervention condition on Multiple Agree inspired by Nevins’ (2007, 2011) Contiguous Agree.

There are additional patterns which the ultimate account of φ CCs must address. Zoogocho, Laxopa, Yalálag, and Yatzachi all have the Strong PCC. Another Zapotec variety, Teotitlán del Valle, is even stricter, ruling out all human objects.

(43) *Moving Wall Generalization*

For any subject–object clitic cluster, if the object clitic cannot be gender G, then it cannot be gender G’, where G’ > G on the hierarchy.

How far to the right a ‘wall’ of stars is can vary: if a column is ungrammatical, so are all columns to its left.

<i>Laxopa, Yalálag, Yatzachi, and Zoogocho</i>						<i>Teotitlán</i>							
	1	2	3.EL	3.HU	3.AN	3.IN		1	2	3.EL	3.HU	3.AN	3.IN
1	–	*	✓	✓	✓	✓	1	–	*	*	*	✓	✓
2	*	–	✓	✓	✓	✓	2	*	–	*	*	✓	✓
3.EL	*	*	–	✓	✓	✓	3.EL	*	*	–	*	✓	✓
3.HU	*	*	✓/*	–	✓	✓	3.HU	*	*	*	–	✓	✓
3.AN	*	*	✓/*	✓/*	–	✓/*	3.AN	*	*	*	*	–	✓
3.IN	*	*	*	*	*	–	3.IN	*	*	*	*	*	–

Liberal Contiguous Agree is, perhaps, an unusual intervention constraint. Future work will have to address how to square this condition — which *allows* intervention between a probe and its goal, as long as it is of a certain kind — and the usual locality condition on Agree, which *prohibits* intervention to ensure closest search.

References

- Anagnostopoulou, Elena. 2003. *The syntax of ditransitives: Evidence from clitics*. Berlin: Mouton de Gruyter.
- Anagnostopoulou, Elena. 2005. Strong and weak person restrictions: A feature checking analysis. In *Clitic and affix combinations: Theoretical perspectives*, eds. Lorie Heggie and Francisco Francisco Ordóñez, 199–235. Amsterdam: John Benjamins.
- Béjar, Susana and Milan Rezac. 2003. Person licensing and the derivation of PCC effects. In *Romance linguistics: Theory and acquisition*, eds. Ana Teresa Pérez Leroux and Yves Roberge, 49–62. Amsterdam: John Benjamins.
- Béjar, Susana and Milan Rezac. 2009. Cyclic Agree. *Linguistic Inquiry* 40:35–73.
- Bonet, Eulalia. 1991. Morphology after syntax: Pronominal clitics in Romance. Ph.D. Dissertation, Massachusetts Institute of Technology.
- Butler, Inez M. 1980. *Gramática zapoteca: Zapoteco de Yatzachi el Bajo*. Mexico City: Instituto Lingüístico de Verano.
- Cardinaletti, Anna and Michal Starke. 1999. The typology of structural deficiency: A case study of the three classes of pronouns. In *Clitics in the languages of Europe*, ed. H. C. van Riemsdijk, 145–233. Berlin: Mouton de Gruyter.

- Han, Chung-hye, Jeffrey Lidz and Julien Musolino. 2007. V-raising and grammar competition in Korean: Evidence from negation and quantifier scope. *Linguistic Inquiry* 38:1–47.
- Harley, Heidi and Elizabeth Ritter. 2002. Person and number in pronouns: A feature-geometric analysis. *Language* 78:482–526.
- Hiraiwa, Ken. 2001. Multiple Agree and the defective intervention constraint in Japanese. *MIT Working Papers in Linguistics* 40:67–80.
- Hiraiwa, Ken. 2005. Dimensions of symmetry in syntax: Agreement and clausal architecture. Ph.D. Dissertation, Massachusetts Institute of Technology.
- López, Filemón and Ronaldo Newberg. 2005. *La conjugación del verbo zapoteco, zapoteco de Yalálag*. Mexico City: Instituto Lingüístico de Verano.
- Marlett, Stephen A. 2010a. Personal pronouns: Inventory. In *The Zapotec grammar files*, eds. Cheryl A. Black, H. Andrew Black, and Stephen A. Marlett. SIL International.
- Marlett, Stephen A. 2010b. The *la'a* ‘base’ plus enclitic pronoun phrase. In *The Zapotec grammar files*, eds. Cheryl A. Black, H. Andrew Black, and Stephen A. Marlett. SIL International.
- Nevins, Andrew. 2007. The representation of third person and its consequences for person-case effects. *Natural Language and Linguistic Theory* 25:273–313.
- Nevins, Andrew. 2011. Multiple agree with clitics: Person complementarity vs. omnivorous number. *Natural Language and Linguistic Theory* 29:939–971.
- Ormazabal, Javier and Juan Romero. 2007. The object agreement constraint. *Natural Language and Linguistic Theory* 25:315–347.
- Perlmutter, David. 1971. *Deep and surface structure constraints in syntax*. New York: Holt, Reinhart, and Winston.
- Preminger, Omer. 2014. *Agreement and its failures*. Cambridge, MA: MIT Press.
- Richards, Marc. 2008. Defective Agree, case alternations, and the prominence of person. *Linguistische Arbeits Berichte* 86:137–161.
- Sonnenschein, Aaron. 2004. A descriptive grammar of San Bartolomé Zoogocho Zapotec. Ph.D. Dissertation, University of Southern California.
- Toosarvandani, Maziar. 2017. On reaching agreement early (and late). In *Asking the right questions: Essays in honor of Sandra Chung*, eds. Jason Ostrove, Ruth Kramer, and Joseph Sabbagh, 124–138. Santa Cruz, CA: Department of Linguistics, University of California, Santa Cruz.
- Walkow, Martin. 2012. Cyclic agree derives restrictions on cliticization in Classical Arabic. In *Papers from Arabic Linguistics XXVI: Papers from the annual symposium on Arabic linguistics, 2012*, eds. Reem Khamis-Dakwar and Karen Froud, 135–160. Amsterdam: John Benjamins.